

ST353BQL



Familie	Vaatwasser
Commerciële breedte	60 cm
Nishoogte	82 cm
Installatie	Volledig geïntegreerd
Deur paneel	Niet meegeleverd
Aantal korven	3, FlexiDuo
EAN-code	8017709306892



Programs



Aantal programma's	10+1	Auto sensor 45-65	Ja
Wastemperatuur	38, 45, 50, 55, 65, 70, 75 °C	Mix	Ja
Weken	Ja	Stil (-2dB)	Ja
Snel 27'	Ja	Intensief	Ja
Krystal	Ja	Zelf reinigen	Ja
Snel - Volledig 60'	Ja	Hygiëne 99,9%	Ja
Eco	Ja		

Opties



Dry Assist + opties	Ja	FlexiZone ½ (halve beladingsmogelijkheid)	Ja
Delay timer optie	Tot 24 uur, i.c.m. automatisch spoelen	Optie speciale programma's	Ja

Korven



Kleur korven	Grijs	Maximum afmetingen bord dat in bovenste korf kan worden geladen	19,0 cm
Kleur korfcomponenten	Grijs	Onderkorf	Met 4 opvouwbare rekken
Handgreep	Op onder- en bovenkorf		
Bovenkorf	Met 1 opvouwbaar rek		
Glazen houder	Ja		

In hoogte verstelbare bovenkorf 3 niveaus

Onderkorf met anti-drup inserts Ja

Maximum afmetingen bord dat in onderste korf kan worden geladen 30,0 cm

Kleur binnenonderdelen Groen

Technische specificaties



Breedte product	598 mm
Diepte product	545 mm
Type display	3 cijfers
Hoogte product	818 mm
Bediening	Elektronisch
Display	Instelling Delay timer, Programma duur indicator
Grafische weergave programma's	Symbolen
Aan/uit indicator	Ja
Zout indicator	Indicator (lampje)
Glansspoelmiddel indicator	Indicator (lampje)
Indicator einde cyclus	ActiveLight
Auto switch-off	Yes
Wassysteem	Planetarium
Derde sproeiarm	Enkel
Waterontkalker	Elektronisch instelbaar
Aquatest sensor	Ja

Overstroombeveiliging Total Acquastop

Watertoevoer Enkel; koud en warm water tot 60°C - energiebesparing tot 35%

Maximale waterhardheid 100°FH;58°dH

Droogstelsysteem Natuurlijk condensor drogen met Dry Assist + automatische deuropeningssysteem aan het einde van de cyclus

Stoombeveiliging Van kunststof

Materiaal kuip Roestvrij staal

Filter Roestvrij staal

Verborgen verwarmingselement Ja

Scharnieren Zelfbalancerend met vast steunpunt

Min. en max. frontaal paneelgewicht 2 - 9 kg

Min. en max. plinthoogte 100 - 228 mm

Verstelbare voetjes 7 cm, van 820 tot 890 mm

Back cover Ja

Diepte vaatwasser met open deur (mm) 1146 mm

Voetjes achterzijde vanaf de voorkant regelbaar Ja

Bovenbedekking Van kunststof

Performance / Energy Label - Reg. 2019



Energie-efficiëntieklasse (wascyclus)	B
Energy consumption [per 100 cycles, based on the eco programme]	64 kWh
Nominale capaciteit (ps)	14
Water verbruik (per cyclus)	9.0 litres

Programmaduur	4:25 h:min
Geluidsniveau	45 dB(A) re 1 pW
Akoestisch geluidsemissieklasse	C
Energy efficiency Index (EEI)	37.8

Elektrische aansluiting

Aansluitwaarde	1800 W	Type aansluiting	Single-phase
Stroom	10 A	Lengte voedingskabel	140 cm
Spanning	220-240 V	Stekker	(F;E) Schuko
Frequentie	50 Hz		

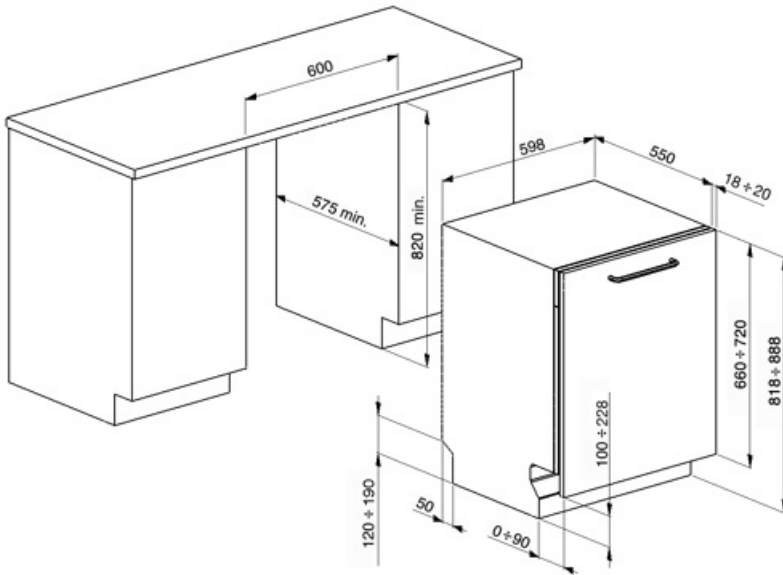

Compatibele Accessoires



KIT82CN



KIT82SPRAN



KIT82SPRX



KIT82CX



KIT82SPRMW

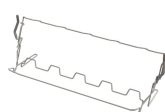

KITGH

Kit glazen houder. Deze moet op de eerste mand worden gemonteerd, maar alleen als er inklapbare rekken zijn

KITPL60FABN

Kit in zwarte kleur in hoogte verstelbaar. Kan over alle volledig geïntegreerde en onderbouwmodellen met vast steunpunt worden gemonteerd. Kan ook worden geïnstalleerd op de modellen met variabel draaipunt of flexifit-scharnieren.

KITPL60FABB

Kit in witte kleur in hoogte verstelbaar. Kan over alle volledig geïntegreerde en onderbouwmodellen met vast steunpunt worden gemonteerd. Kan ook worden geïnstalleerd op de modellen met variabel draaipunt of flexifit-scharnieren.

KITPLV2























Kit verlengstuk voor vaatwasser en wasmachine: lengte 2 mtr.

KITPL60FABX

Kit in roestvrij staal in hoogte verstelbaar. Kan over alle volledig geïntegreerde en onderbouwmodellen met vast steunpunt worden gemonteerd. Kan ook worden geïnstalleerd op de modellen met variabel draaipunt of flexifit-scharnieren.



Symbols glossary

	Activelight is een led die een rode stip projecteert op de vloer onder de vaatwasser als het apparaat in gebruik is		Aquatest meet de helderheid van het water tijdens een automatisch programma en zorgt automatisch voor een minimaal verbruik van water en energie
	To improve the drying of dishes without leaving stains.		Energy efficiency class B
	82 cm high		Vertragingstimer: De uitgestelde timer kan de start van het programma tot 24 uur uitstellen.
	The Dry Assist + option, in addition to saving energy, ensures perfect drying of the dishes by opening the door automatically at the end of the washing cycle.		FlexiDuo: The FlexiDuo 3rd cutlery basket allows you to arrange cutlery or small cups, ladles, or bulky utensils however you like: it consists of two separate and moveable modules.
	FlexiZone: The ½ load flexizone allows you to wash a reduced load saving energy, water and time and there are no restrictions on where the items are placed.		Noise Level: Excellent insulation and special devices keep noise to a minimum.
	The Planetarium washing system, with high rotations per minute, guarantees complete coverage of the tank, thanks to the simultaneous rotation of base and sprayers, and excellent washing results.		Auto 45°- 65°: The auto programme regulates the length of a cycle depending on the need for a pre-wash and the number of rinses required.
	Crystals: The Crystals programme is dedicated to delicate dishes such as glasses and china.		Eco: Eco, this economic wash programme uses a low amount of water and energy in order to provide the most environmentally friendly cleaning option.
	Mix: The Mix programme is suitable for mixed crockery and everyday pots and pans, without any particular incrustation.		Soak programme: The soak programme provides a rinse to prevent dirt from drying.
	Express 27': The Express 27' programme is a quick wash cycle, at low temperatures, for lightly soiled dishes.		Ultraclean: The Ultraclean option performs a final rinse at a high temperature of 70°C eliminating virtually all bacteria.
	14 place settings: Number of place settings.		Total Acquastop: In addition to the partial Acquastop protection present in all Smeg dishwashers, some models have an electronic device fitted to the water intake hose, which monitors water levels in the machine, detects leaks in the hose and switches off the water supply immediately when necessary.
	System WaterSave ensures the best washing results with minimal water consumption depending on the model of dishwasher.		Quick wash cycle for normally soiled mixed loads such as dishes and pans, even with dried-on residues. Dishes are washed and dried in 60 minutes.



Dishwasher cleaning cycle. The cycle should be started with the machine empty, without dishes. It is recommended to run the program every 2-3 months, using special dishwasher detergents.



Allows you to enable additional programs when selected together with any wash cycle.



The work aimed at continuous improvement has allowed the creation of the second generation of the Inverter motor 2.0, characterised by greater efficiency and durability over time, which allows very high performance and a lower energy consumption and noise level.



SILENT: Wash cycle suitable for normally soiled dishes, even with dried-on residues. Ensures maximum noise reduction and is therefore ideal if you wish to run it during the night.



HYGIENE 99.9% High-temperature washing programme. The 75° rinse guarantees the removal of 99.9% of germs and bacteria.